

# DMX-Stepper RDM

User manual



## **Content**

Important Notes .....	3
Description.....	4
Data Sheet.....	5
Content .....	5
Connection .....	6
LED-Display-Codes .....	7
DMX-Addressing .....	8
Operation Modes .....	9
Micro-Step-Setting .....	13
Step Motor Driver .....	14
A4988 (Delivery Status) .....	14
TMC2100 SilentStepStick .....	15
TMC2208 .....	15
External Stepper Motor Driver.....	16
RDM .....	18
Initialization .....	23
Reset via DMX .....	24
End-Switch Configuration.....	24
Maximum and minimum step speed.....	25
Enable step motor driver.....	25
Factory Reset .....	27
Firmware-Update .....	28
Dimension.....	29
Accessory .....	30
Revision History.....	31
CE-Conformity .....	32
Disposal.....	32
Warning .....	32
Risk-Notes .....	33

## Important Notes



For your own safety, please read this user manual and warnings carefully before installation.



A Firmware Update is recommended after receiving the item. This is the only way to ensure that the device has the latest version. The latest firmware is available on the homepage.

## Description

The **DMX-Stepper RDM** is designed for control a stepping motor (Stepper) via DMX.

### Several Operation Modes

Several operating modes allow a continuous operation with variable speed or the starting of defined positions. The minimum and maximum step speed as well as the number of steps and number of positions can be set individually.

### RDM Support

The DMX-Stepper RDM allows settings via RDM over DMX.

### Free RDM-Software

To set the parameters via RDM, our free RDM Configurator software is available as download from our website [www.dmx4all.de](http://www.dmx4all.de).

### Lockable Device Settings

The RDM parameters *Lock Pin* and *Lock State* allow or avoid changings of saved RDM parameters in order to prevent unauthorized changes.

### Replaceable Step Motor Driver

The standard Pololu A4988 step motor driver is suitable for power supplies from 8-24V and can control a current of 2A per phase.

Alternatively, the stepper motor driver can also be replaced with a SilentStepStick with Trinamic TMC2100 or, alternatively, an external stepper motor driver can be used with the BRIDGE stepper motor driver.

### Micro Step Operation Modes

The following micro step operation modes are supported Full-Step (1/1) / Half-Step (1/2) / Quarter-Step (1/4) / Eighth-Step (1/8) / Sixteenth-Step (1/16)

### Left and Right End-Switch

Inputs for a left and right end-switch allow the travel distance to be limited. These can optionally be deactivated after initialization.

### Activate / Deactivate the Step Motor Driver

The stepper motor driver can optionally be activated or deactivated via DMX.

### Settable Initialization process

Optionally, initialization can be carried out after switching on. The number of steps left and right as well as step speed can be set for this process. The motor then moves left and right until the end switch is reached and saves this position as the initial point.

### Reset per DMX

During operation the initialization process (Reset) can optionally be started via DMX.

### Firmware-Update-Function

To us future functions the DMX-Stepper RDM offers the Firmware-Update-Function via USB or RDM.

## Data Sheet

<b>Power supply:</b>	8-24V DC / 50mA (without connected motor)
<b>Protocol:</b>	DMX512 RDM
<b>DMX channels:</b>	1-5 DMX channels (depends on operation mode)
<b>Output Driver:</b>	Pololu A4988 Step Motor Driver (Standard)  as accessory optionally available: TMC2100 SilentStepStick Bridge for external Stepper Driver
<b>Stepper-Voltage:</b>	8-24V DC (corresponds to the supply voltage)
<b>Stepper-Current:</b>	max. 2A with Pololu A4988 stepper motor driver
<b>Connections:</b>	Screw terminals
<b>Dimension:</b>	80mm x 39mm

## Content

1x	DMX-Stepper RDM
1x	Screw terminal 2in / RM3,5
2x	Screw terminal 3pin / RM3,5
1x	Screw terminal 4pin / RM3,5
1x	Heat sink for stepper driver
1x	Quick guide german / english

## Connection



Connection with bipolar stepper motor



Connection with unipolar stepper motor



### **ATTENTION:**

This DMX-Stepper RDM is **NOT PERMITTED** for applications in which safety-relevant requirements are made or dangerous situations can arise!

## LED-Display-Codes

The integrated green LED is a multi-function display.

During to the normal operation mode the LED lights permanently. In this case the device is working.

Furthermore, the LED shows the current status. In this case the LED lights up in short pitches and then is missing for longer time.

The number of the flashing lights is equal to the status number.

Status-Number	Error	Description / Troubleshooting
1	DMX error	No DMX signal detected ➔ Check DMX signal
2	Address error	No valid DMX start address is set ➔ Set DMX start address
3	Device error	A fault was detected within the device. ➔ Device to the manufacturer for inspection

## DMX-Addressing

The starting address is adjustable via switches 1 up to 9 or via RDM.

Thereby switch 1 has the valency  $2^0$  (=1), switch 2 the valency  $2^1$  (=2) and so on until switch 9 has the valency  $2^8$  (=256).

The switches showing ON represent in sum the starting address.

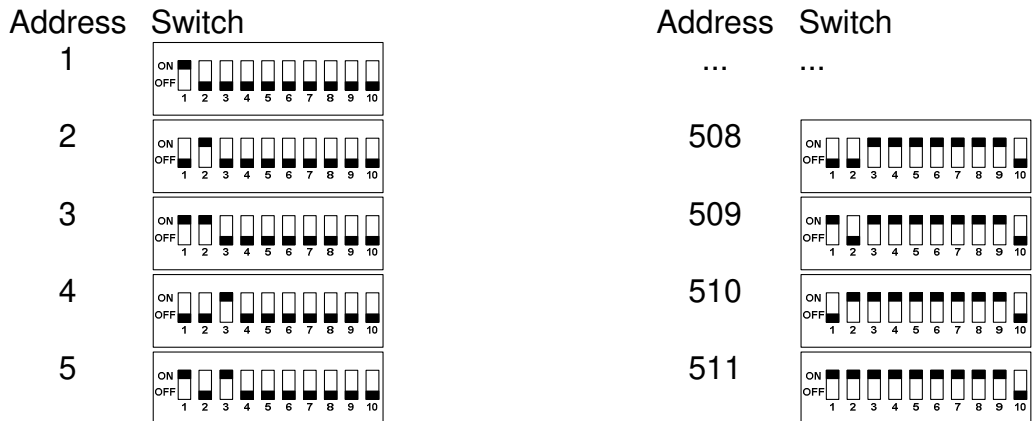

The DMX start address can also be set via the RDM parameter `DMX_STARTADDRESS`.

If a DMX start address is set via the DIP switches, this has priority over the start address set via RDM.

## Operation Modes

The **DMX-Stepper RDM** has several operation modes (Personality).

The number of needed DMX channels and its assignment as well as the stepper control depends on the Personality.

The Personality is to select via the RDM-Parameter DMX\_PERSONALITY.

### Speed and direction via one DMX-Channel

MODE 0 (Personality 1)

DMX Channel	Value	Description
1	0-126 127-129 130-255	Left-hand rotation fast → slow STOP Right-hand rotation slow → fast
(Optional)		Reset via DMX
(Optional)		Driver enable

### Speed and Direction via each one DMX channel

MODE 1 (Personality 2)

DMX Channel	Value	Description
1	0 1-255	STOP slow → fast
2	0-127 128-255	Right-hand rotation Left-hand rotation
(Optional)		Reset via DMX
(Optional)		Driver enable

### Speed and direction via one DMX channel / only one direction

MODE 2 (Personality 3)

DMX Channel	Value	Description
1	0 1-255	STOP slow → fast
(Optional)		Reset via DMX
(Optional)		Driver enable

**Position index and speed via one DMX channel without Overroll**

MODE 3 (Personality 4)

This mode allows a start-up from several positions. During the configuration the number of positions will be defined. The interface spreads the positions even between step 0 and the last step. Also the DMX-Value area will be divided even.

By controlling the motor no Roll-Over is used. That means that e.g. the way of the last position to the first position takes about all other positions.

DMX Channel	Value	Description
1	0-255	Position index
2	0-255	Slow → Fast
(Optional)		Reset via DMX
(Optional)		Driver enable

*Example:* 4 positions and 400 steps are predefined.  
Thereby this results in the following DMX-value assignments:

DMX Channel	Value	Description
1	0-63	Position 1
	64-127	Position 2
	128-191	Position 3
	192-255	Position 4

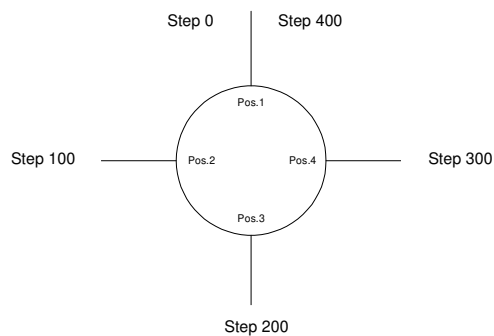

**Position index and speed via one DMX channel with Roll-Over**

MODE 4 (Personality 5)

This mode is identical to the prior Mode 3, with the exception that here is a Roll-Over used and so the shortest way to the new position is taken.

**8Bit position and speed without Roll-Over**

MODE 5 (Personality 6)

This mode divides the steps equal to the Position-Values.

DMX Channel	Value	Description
1	0-255	Position
2	0-255	Slow → Fast
(Optional)		Reset via DMX
(Optional)		Driver enable

**8Bit position and speed with Roll-Over**

MODE 6 (Personality 7)

This mode is identical to the prior Mode 5, with the exception that here is a Roll-Over used and so the shortest way to the new position is taken.

**16Bit position and speed without Roll-Over**

MODE 7 (Personality 8)

This mode allows to run-up one motors step. This step to run-up is thereby specified as 16Bit-Value via 2 DMX-Addresses.

DMX Channel	Value	Description
1	0-255	Step HIGH
2	0-255	Step LOW (fine)
3	0-255	slow → fast
(Optional)		Reset via DMX
(Optional)		Driver enable

**16Bit position and speed with Roll-Over**

MODE 8 (Personality 9)

This mode is identical to the prior Mode 7, with the exception that here is a Roll-Over used and so the shortest way to the new position is taken.

**8Bit Position and speed without Roll-Over with EndlessRotation**

MODE 9 (Personality 10)

This mode divides the steps of the motor evenly to the position values and offers the possibility to let the stepper rotate endlessly via another DMX channel.

DMX Channel	Value	Description
1	0-255	Position
2	0-255	Slow → fast
3	0-127 128-191 192-255	Go to position Continous left rotation Continous right rotation
(Optional)		Reset via DMX
(Optional)		Driver enable

**MODE1 with manuell control via IN1 and IN2**

MODE 10 (Personality 11)

This mode is identical to mode 1, with the exception that the stepper movement occurs via the inputs IN1 and IN2 independently of the DMX value. The maximum speed is used.

## Micro-Step-Setting

The Micro-Step-Setting is to set via Jumper 1-3.

The adjusting in which micro-step-resolution the stepper motor will be controlled occurs about Jumper 1-3.

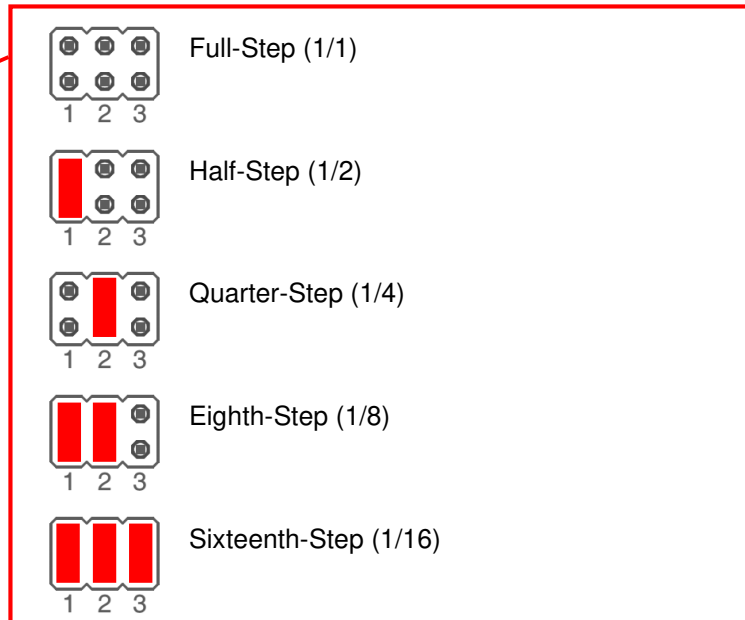
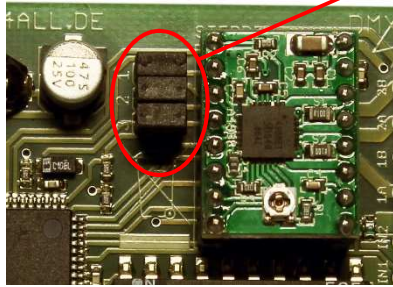

The Micro-Step setting affects only the set step motor driver.

In case of using alternative step motor drivers, it could be necessary to let Jumper open (MS1, MS2 and MS3 at step motor driver see following pages).

## Step Motor Driver

The DMX-Stepper RDM uses the commonly used step-stick stepper motor driver.

The pin assignment of the driver socket is as follows:

○ ENABLE	VMOT	○
○ MS1	GND	○
○ MS2	2B	○
○ MS3	2A	○
○ $\overline{\text{RESET}}$	1A	○
○ SLEEP	1B	○
○ STEP	VDD	○
○ DIR	GND	○



Note, to plug the stepper motor driver only in the correct orientation and only when it is disconnected to the power supply!

The motor connections must be pointed to the motor connection. Plug in with the wrong orientation or with connected power supply will destroy the DMX-Stepper RDM and / or the stepper modules.

### ***A4988 (Delivery Status)***

The stepper motor driver A4988 is plugged onto the **DMX-Stepper RDM** in the delivery status.

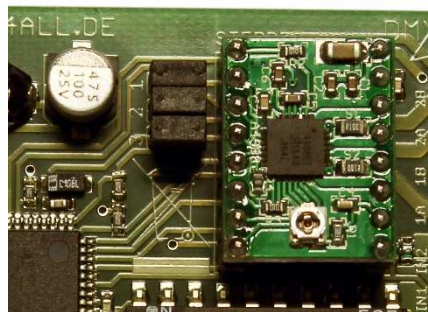

## *TMC2100 SilentStepStick*

A SilentStepStick with Trinamic TMC2100 can also be plugged to the **DMX-Stepper RDM**. In this case the connections CFG1, CFG2 and CFG3 must not be connected.



## *TMC2208*

To use the DMX-Stepper RDM with a Trinamic TMC2208, plug the TMC2208 with the motor connector to the outside of the board as shown in the picture. It may be necessary to remove the connection pins MS1, MS2 and MS3 and not to connect them.

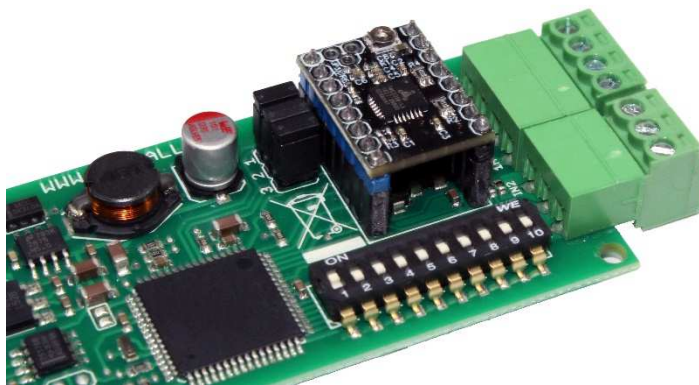

**External Stepper Motor Driver**

A stepper motor driver BRIDGE is available as accessory for the **DMX-Stepper RDM** (EXTERNAL DRIVER BRIDGE).

With the stepper motor driver BRIDGE, it is possible to connect external stepper motor driver to the DMX-Stepper RDM.

The signals STEP, DIR and ENABLE are bridged by the stepper motor driver to the motor connection and can be used in this way for controlling an external stepper motor driver.

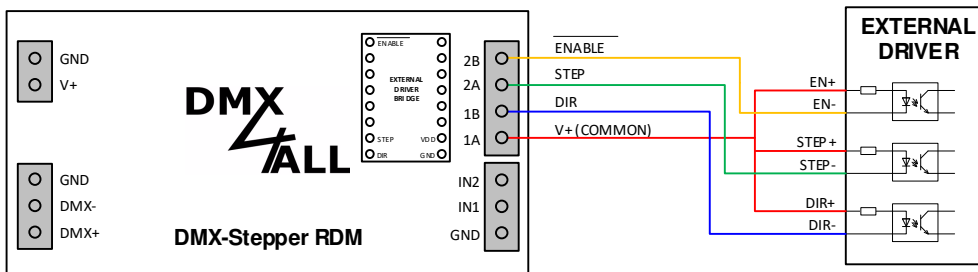

**Connection sample with TB6600:**

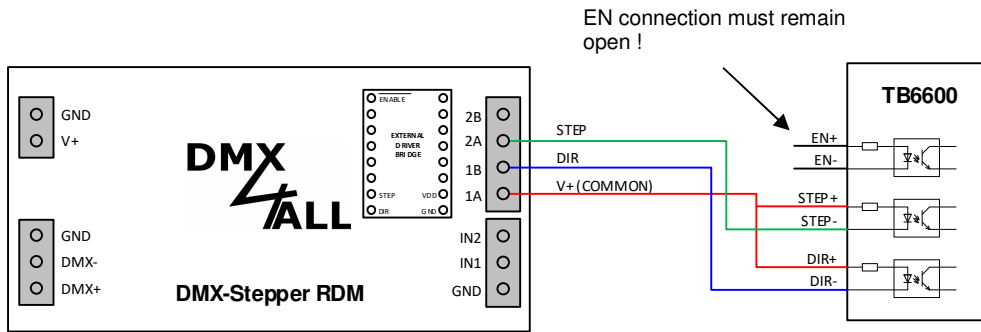

**Connection sample with DM422C:**

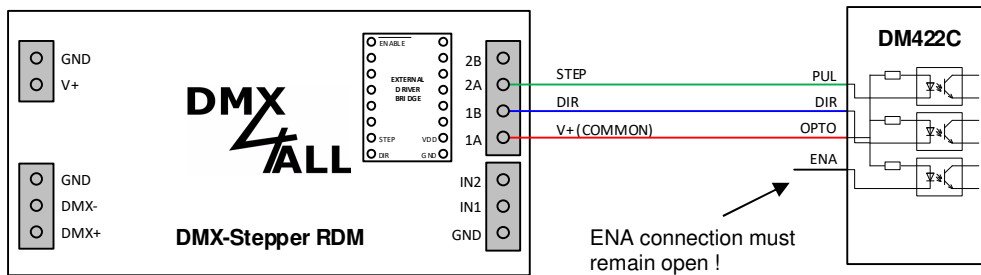

**Connection sample with DM542:**

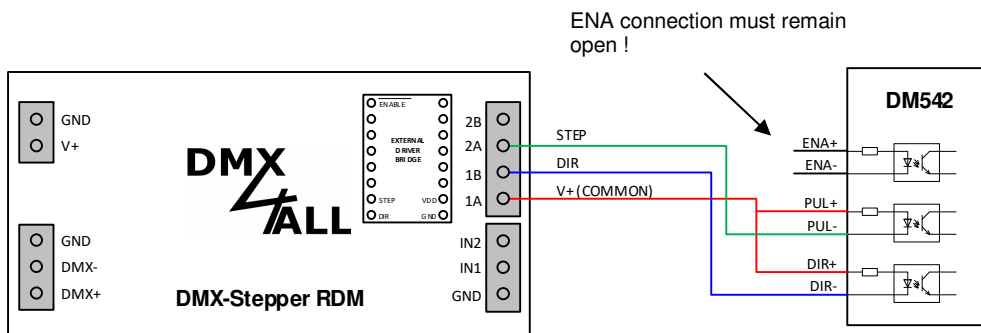

## RDM

RDM is the short form for **R**emote **D**evice **M**anagement.

As soon as the device is within the system, device-dependent settings occur remotely via RDM command due to the uniquely assigned UID. A direct access to the device is not necessary.



If the DMX start address is set via RDM, all address switches at the device must be set to OFF ! A DMX start address set by the address switches is always prior !

This device supports the following RDM commands:

Parameter ID	Discovery Command	SET Command	GET Command	ANSI/ PID
DISC_UNIQUE_BRANCH	✓			E1.20
DISC_MUTE	✓			E1.20
DISC_UN_MUTE	✓			E1.20
DEVICE_INFO			✓	E1.20
SUPPORTED_PARAMETERS			✓	E1.20
PARAMETER_DESCRIPTION			✓	E1.20
SOFTWARE_VERSION_LABEL			✓	E1.20
DMX_START_ADDRESS		✓	✓	E1.20
DEVICE_LABEL		✓	✓	E1.20
MANUFACTURER_LABEL			✓	E1.20
DEVICE_MODEL_DESCRIPTION			✓	E1.20
IDENTIFY_DEVICE		✓	✓	E1.20
FACTORY_DEFAULTS		✓	✓	E1.20
DMX_PERSONALITY		✓	✓	E1.20
DMX_PERSONALITY_DESCRIPTION			✓	E1.20
DISPLAY_LEVEL		✓	✓	E1.20
LOCK_STATE		✓	✓	E1.37
LOCK_STATE_DESCRIPTION			✓	E1.37
LOCK_PIN		✓		E1.37

Parameter ID	Discovery Command	SET Command	GET Command	ANSI/PID
SERIAL_NUMBER <sup>1)</sup>			✓	PID: 0xD400
ENDSWITCH_CONFIG <sup>1)</sup>		✓	✓	PID: 0xD419
DRIVER_ENABLE <sup>1)</sup>		✓	✓	PID: 0xD420
STEPPER_POSITIONS <sup>1)</sup>		✓	✓	PID: 0xD421
STEP_COUNT <sup>1)</sup>		✓	✓	PID: 0xD422
SPEED_MIN <sup>1)</sup>		✓	✓	PID: 0xD423
SPEED_MAX <sup>1)</sup>		✓	✓	PID: 0xD424
RAMP_CONFIG <sup>1)</sup>		✓	✓	PID: 0xD425
RESET_VIA_DMX <sup>1)</sup>		✓	✓	PID: 0xD426
INIT_STEPS_LEFT <sup>1)</sup>		✓	✓	PID: 0xD427
INIT_STEPS_RIGHT <sup>1)</sup>		✓	✓	PID: 0xD428
INIT_SPEED <sup>1)</sup>		✓	✓	PID: 0xD429

1) Manufacturer depending RDM control commands (MSC - Manufacturer Specific Type)

Manufacturer depending RDM control commands:

**SERIAL\_NUMBER**

PID: 0xD400

Outputs a text description (ASCII-Text) of the device serial number.

GET Send: PDL=0  
 Receive: PDL=21 (21 Byte ASCII-Text)

**ENDSWITCH\_CONFIG**

PID: 0xD419

This parameter sets the end-switch configuration.

GET Send: PDL=0  
 Receive: PDL=1 (1 Byte end-switch configuration)

SET Send: PDL=1 (1 Byte end-switch configuration)  
 Receive: PDL=0

## **DRIVER\_ENABLE**

PID: 0xD420

This parameter sets the Driver-Enable configuration.

GET	Send: PDL=0	
	Receive: PDL=1	(1 Byte driver enable configuration)
SET	Send: PDL=1	(1 Byte driver enable configuration)
	Receive: PDL=0	

## **STEPPER\_POSITIONS**

PID: 0xD421

This parameter sets the number of position.

GET	Send: PDL=0	
	Receive: PDL=1	(1 Byte number of positions)
SET	Send: PDL=1	(1 Byte number of positions)
	Receive: PDL=0	

## **STEP\_COUNT**

PID: 0xD422

This parameter sets the number of steps.

GET	Send: PDL=0	
	Receive: PDL=2	(2 Byte number of steps)
SET	Send: PDL=2	(2 Byte number of steps)
	Receive: PDL=0	

**SPEED\_MIN**

PID: 0xD423

This parameter sets the minimum step speed.

GET    Send:    PDL=0  
       Receive: PDL=2    (2 Byte minimum step speed)

SET    Send:    PDL=2    (2 Byte minimum step speed))  
       Receive: PDL=0

**SPEED\_MAX**

PID: 0xD424

This parameter sets the maximum step speed.

GET    Send:    PDL=0  
       Receive: PDL=2    (2 Byte maximum step speed)

SET    Send:    PDL=2    (2 Byte maximum step speed)  
       Receive: PDL=0

**RAMP\_CONFIG**

PID: 0xD425

This parameter sets the ramp configuration.

GET    Send:    PDL=0  
       Receive: PDL=1    (1 Byte ramp configuration)

SET    Send:    PDL=1    (1 Byte ramp configuration)  
       Receive: PDL=0

**RESET\_VIA\_DMX**

PID: 0xD426

This parameter sets the reset configuration

GET    Send:    PDL=0  
       Receive: PDL=1    (1 Byte reset configuration)

SET    Send:    PDL=1    (1 Byte reset configuration)  
       Receive: PDL=0

**INIT\_STEPS\_LEFT**

PID: 0xD427

This parameter sets the number of steps for the initialization left.

GET    Send:    PDL=0  
       Receive: PDL=2    (2 Byte number of steps)

SET    Send:    PDL=2    (2 Byte number of steps)  
       Receive: PDL=0

**INIT\_STEPS\_RIGHT**

PID: 0xD428

This parameter sets the number of steps for the initialization right.

GET    Send:    PDL=0  
       Receive: PDL=2    (2 Byte number of steps)

SET    Send:    PDL=2    (2 Byte number of steps)  
       Receive: PDL=0

**INIT\_SPEED**

PID: 0xD429

This parameter sets the number of steps during the initialization

GET    Send:    PDL=0  
       Receive: PDL=2    (2 Byte number of steps)

SET    Send:    PDL=2    (2 Byte number of steps)  
       Receive: PDL=0

## Initialization

The **DMX-Stepper RDM** allows an initialization run when it is switched on or started via a DMX value.

The number of left and right initialization steps and the step speed can be set.

The initialization process is configured via the RDM parameters INIT\_STEPS\_LEFT, INIT\_STEPS\_RIGHT and INIT\_SPEED.

If the number of initialization steps is 0, the initialization will not be performed for the set direction.

If initialization is carried out for both directions, the left direction is executed first and then the right direction.

The stepper motor rotates in each direction until input IN1 (left) or IN2 (right) is activated or until the set number of steps is reached.

So, the motor stops either when the contact is triggered or when a mechanical stop is reached.

The reached position to the left is used as the 0 position.

Examples of construction:

Mechanical stop:  
(Touch)

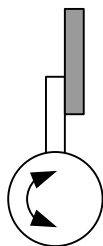

Electrical stop:  
(Switching contact at 0-position)

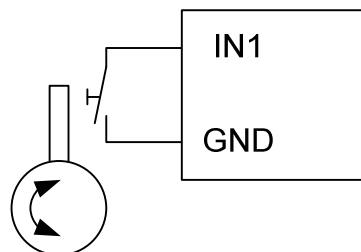

## ***Reset via DMX***

The initialization can be run via a reset using a DMX value during operation.

This option is to activate via the RDM parameter RESET\_VIA\_DMX.

After activation, another DMX channel is used to trigger a reset of the DMX-Stepper RDM.

To start the reset, a DMX value of 128 or greater must be sent on the corresponding DMX channel for the number of DMX frames set, which changes to a value less than 128.

<b>Value</b>	<b>Description</b>
128-255 → 0-127	Make initialization, if DMX value from 128 or higher switches smaller than 128

## ***End-Switch Configuration***

The end-switch configuration is set via the RDM parameter ENDSWITCH\_CONFIG.

This makes it possible to deactivate the end-switches after initialization.

The following options are available:

- Always enabled
- Left disable after initialize
- Right disable after initialize
- Left & Right disable after initialize

## ***Maximum and minimum step speed***

The maximum and minimum step speed is set via the RDM parameters SPEED\_MIN and SPEED\_MAX.

The step speed can range from 1 step/second to 20,000 steps/second.

## ***Enable step motor driver***

The activation of the stepper motor driver is set via the RDM parameter DRIVER\_ENABLE.

The following options are available:

- Always enabled (inverted)
- Always enabled
- Enable via DMX (inverted)
- Enable via DMX

If Enable via DMX is selected, another DMX channel is used for activation and deactivation.

<b>Value</b>	<b>Description</b>
0-128	Activated / Deactivated (inverted)
128-255	Deactivated / Activated (inverted)

## Lock device settings

The RDM parameters *Lock Pin* and *Lock State* allow or deny changings of saved RDM parameters.

### Lock Pin

The *Lock Pin* parameter is used to define the four-digit pin code number for the lock function.

After entering the correct pin currently in use (*Old PIN*) in the RDM software (e.g. RDM Configurator), the new, desired PIN can be entered via the New PIN field and saved by setting the parameter.

The default *Lock Pin* is always 0000.

### Lock State

The device settings can be locked/locked or unlocked/unlocked via the *Lock State* parameter.

The following lock states are available:

Value	Name	Description
0	Unlocked	Parameters are editable
1	RDM Locked	Parameters cannot be edited via RDM

The device is always *unlocked* when delivered.

To change the *Lock State* parameter, the lock pin (PIN code) is needed.



The RDM parameters *Identify Device*, *Reset Device* and *Display Level* can always be executed, regardless of the *Lock State*.

## Factory Reset



Read all the steps carefully before starting the factory reset.

To reset the DMX-Stepper RDM to the factory settings, the RDM parameter `FACTORY_DEFAULTS` can be used or proceed as follows:

- Turn off the device (Disconnect power supply and USB !)
- Set switch 1 up to 10 on ON
- Turn on the device (Power supply)
- The LED flashes 20x during ca. 3 seconds
  - ➔ Set switch 10 to OFF while LED flashes
- Now, the factory reset is running
  - ➔ LED flashes with error code 4
- Turn off the device (Disconnect power supply and USB !)
- The device can now be used



If a new factory reset is necessary, this process can be repeated.

## Firmware-Update

The **DMX-Stepper RDM** has an update-function which enables transferring prospective firmware-versions.

To make the **Firmware-Update via USB**, proceed as follows:

- The latest firmware including USB-Updater is downloadable
- Turn off the device (Disconnect power supply and USB!)
- Release UPDATE jumper
- Generate USB connection to PC
- If necessary install USB driver
- Start update software **DMX4ALL USB-Updater**
- Select DMX-Stepper RDM from list
- Click *Firmware-Update*
- Select and confirm firmware file (.bin)
- Wait until the update has finished
- Disconnect USB connection and USB
- Pin UPDATE-Jumper again

To make the **Firmware-Update via RDM**, proceed as follows:

- Connect the device to an ArtNet-DMX/RDM Gateway
- Start the software **DMX4ALL RDM-Configurator**
- Select the RDM-Parameter *Firmware-Update*
- Select *SET* parameter or double-click to parameter
- Select Firmware-File (.bin) and confirm
- Wait, until the update has finished



If an error occurs during the update you can start from the beginning at any time. In this case you must turn off the DMX-Stepper RDM and close the software before executing the firmware update again.

# Dimension

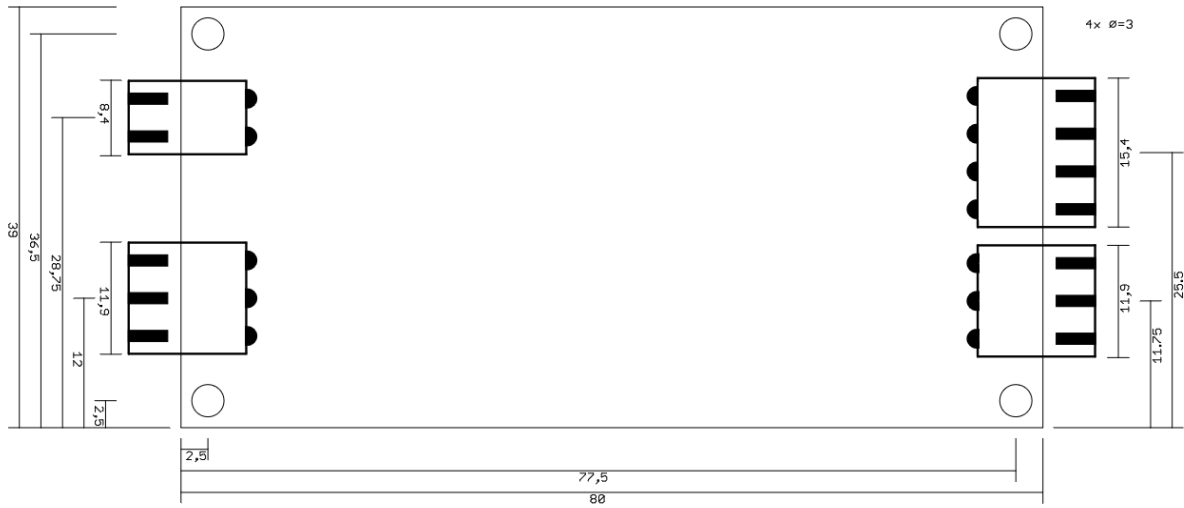

All details in mm

## Accessory

**Step motor driver**  
A4988 / TMC2100

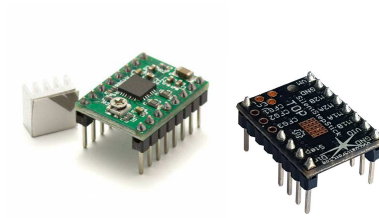

**Step motor driver**  
BRIDGE

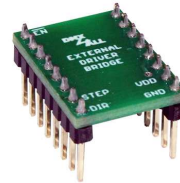

**Step motor**  
NEMA17 12V/400mA



**Power supply**  
12V / 25W (2,1A)



**Screw terminal 3,5mm**  
2pin / 3pin / 4pin



---

## Revision History

### Firmware V4.00

- New Hardware V4 - DMX-Stepper RDM
- Add Firmware-Update via RDM

## CE-Conformity



This assembly (board) is controlled by a microprocessor and uses high frequency. In order to maintain the properties of the module with regard to CE conformity, installation into a closed metal housing in accordance with the EMC directive 2014/30/EU is necessary.

## Disposal



Electronical and electronic products must not be disposed in domestic waste. Dispose the product at the end of its service life in accordance with applicable legal regulations. Information on this can be obtained from your local waste disposal company.

## Warning



This device is no toy. Keep out of the reach of children. Parents are liable for consequential damages caused by nonobservance for their children.

## Risk-Notes



You purchased a technical product. Conformable to the best available technology the following risks should not be excluded:

### **Failure risk:**

The device can drop out partially or completely at any time without warning. To reduce the probability of a failure a redundant system structure is necessary.

### **Initiation risk:**

For the installation of the board, the board must be connected and adjusted to foreign components according to the device paperwork. This work can only be done by qualified personnel, which read the full device paperwork and understand it.

### **Operating risk:**

The Change or the operation under special conditions of the installed systems/components could as well as hidden defects cause to breakdown within the running time.

### **Misusage risk:**

Any nonstandard use could cause incalculable risks and is not allowed.

### **Warning:**

It is not allowed to use the device in an operation, where the safety of persons depend on this device.



DMX4ALL GmbH  
Reiterweg 2A  
D-44869 Bochum  
Germany

Last change: 25.02.2026

© Copyright DMX4ALL GmbH

All rights reserved. No part of this manual may be reproduced in any form (photocopy, pressure, microfilm or in another procedure) without written permission or processed, multiplied or spread using electronic systems.

All information contained in this manual was arranged with the greatest care and after the best knowledge. Nevertheless, errors are to be excluded not completely. It is pointed out that neither a guarantee nor the legal responsibility or any liability for consequences which are due to incorrect information is assumed. This document does not contain assured characteristics. The guidance and the features may be changed at any time and without previous announcement.