

ArtNet-LED-Dimmer 4 MK2

User manual

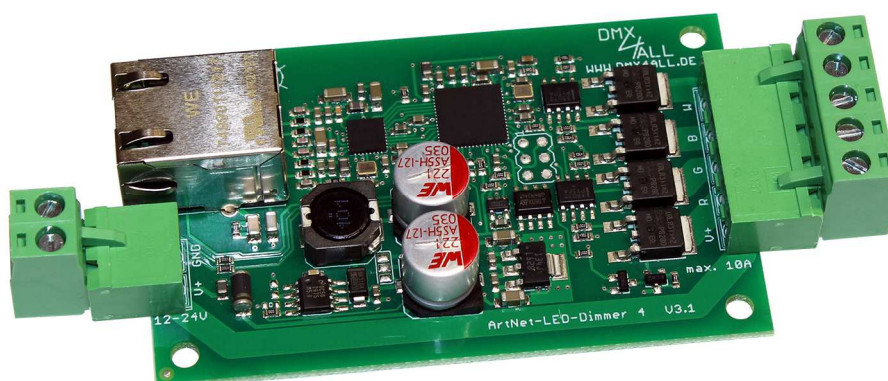

**ART
NET**
ETHERNET

Art-Net™ Designed by and Copyright Artistic Licence Holdings Ltd.

DMX ®
4
ALL



For your own safety, please read this user manual and warnings carefully before installation.

Contents

Description.....	3
Data sheet	4
Content	4
LED-Displays	5
Connection	6
Set the IP with IP-Configurator	7
Set the IP with web browser	7
Device Configuration	8
Master Dimmer	10
User defined color changes/programs	11
Control via Smart Control	14
Execute program / edit via Android App	15
Live-Usage per App	19
Running with WLAN	20
Factory Reset	21
Execute Firmware-Update	22
Dimensions.....	23
Accessory	24
CE-Conformity	25
Disposal.....	25
Risk-Notes	26

Description

The **ArtNet-LED-Dimmer 4 MK2** is a compact LED-Dimmer controlling 4 separate LED outputs. These can be used for RGB+W or for single, single-colored LED-Stripes.

The LEDs connection occurs via removable screw clamps.
Via a RJ45-Connection occurs the connection to Ethernet (ArtNet net work).

High Power Outputs

The outputs can drive a current of 10A.
So, a load of maximum 120W (12V) or rather 240W (24V) results.

10 user defined color changes/programs

The ArtNet-LED-Dimmer 4 MK2 offers more than 10 user defined color changes. These can be created via the web browser or the Android App „DMX4ALL Remote“.

Disengageable LED-Display

The LED-Displays at the ArtNet-LED-Dimmer 4 MK2 are disengageable via ArtNet-Command (AcLedMute) or time-controlled.

Most of all this is very helpful on stages to avoid disturbing “light-points”.

Easy configuration

A user friendly configuration via a web browser allows a fast and uncomplicated setting of all parameters. No special software is necessary, a standard web browser is enough. So, the configuration is possible every time from PC, Smartphone or tablet. For an easy setting of the IP we provide the IP-Configurator as PC-Tool or Android-App for free. The network settings can be leaved unchanged and the IP can be configured without any problems.

Controlling via browser or App with Colorwheel / Slider

The output control is available via an integrated web interface with a Colorwheel. Alternatively each other app which supports Art-Net can be used.

Firmware-Update-Function

To use future functions the ArtNet-LED-Dimmer 4 MK2 offers a Firmware-Update-Function. This can be started from a web browser, so that no direct access to the device is necessary!

DMX4ALL Communication-Interface

The ArtNet-LED-Dimmer 4 MK2 has a further TCP-Communication-Interface. This interface uses the DMX4ALL-Commands with TCP-Commands via TCP-Packages to Port 1001.

Data sheet

Power supply:	12-24V DC The supply voltage must correspond to the voltage for the LED stripe !
LED-Voltage:	12-24V DC (no AC voltage !)
Ethernet:	RJ45
Protocol:	Art-Net™ or DMX4ALL Commands
LED-Connection:	4x (R/G/B + W) max. each 10A in sum 16A with common anode (+) 4 PWM-Signals with 256 steps
PWM-Frequency:	250 Hz
Ausführung:	ArtNet-LED-Dimmer 4 ^{MK2} Built-in circuit board ArtNet-LED-Dimmer 4+ ^{MK2} Aluminum housing
Dimensions:	115mm x 50,5mm x 18mm (Built-in circuit board) 115mm x 74mm x 23mm (Aluminum housing)

Content

1x	ArtNet-LED-Dimmer 4 ^{MK2}
1x	Screw clamps 2pin / RM5
1x	Screw clamps 5pin / RM5
1x	1m RJ45 Net work cable 1:1
1x	Quick guide german and english

LED-Displays

LED green The green LED flashes, if no Ethernet-Connection is available and lights permanently, if an Ethernet-Connection is available.

LED yellow The yellow LED lights up as soon as data are received.

Connection

With RGB-LED-Stripe and LED-Stripe white

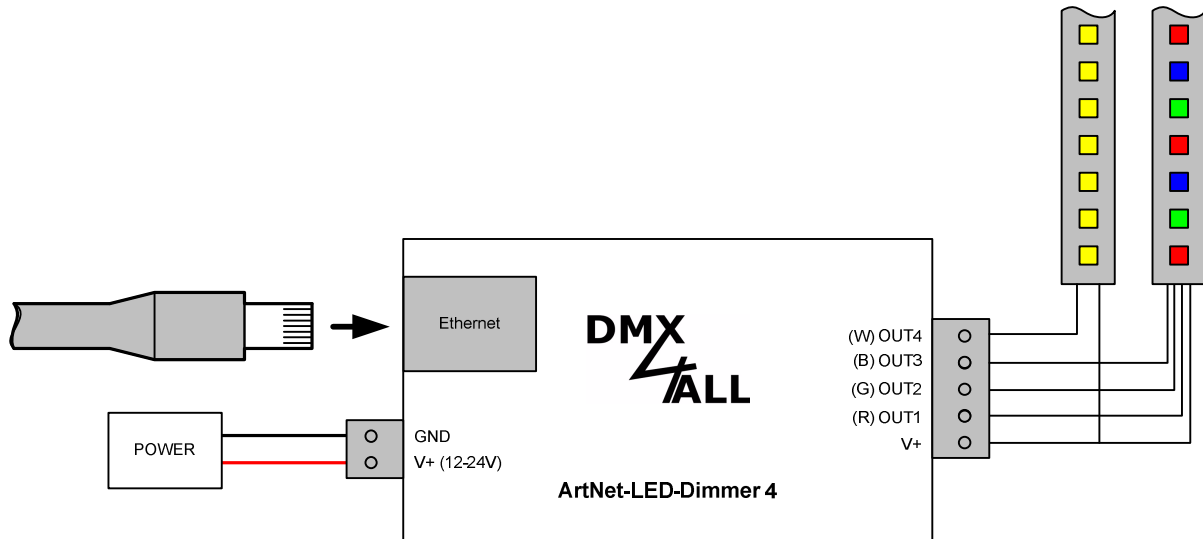

With 4 single color LED-Stripes

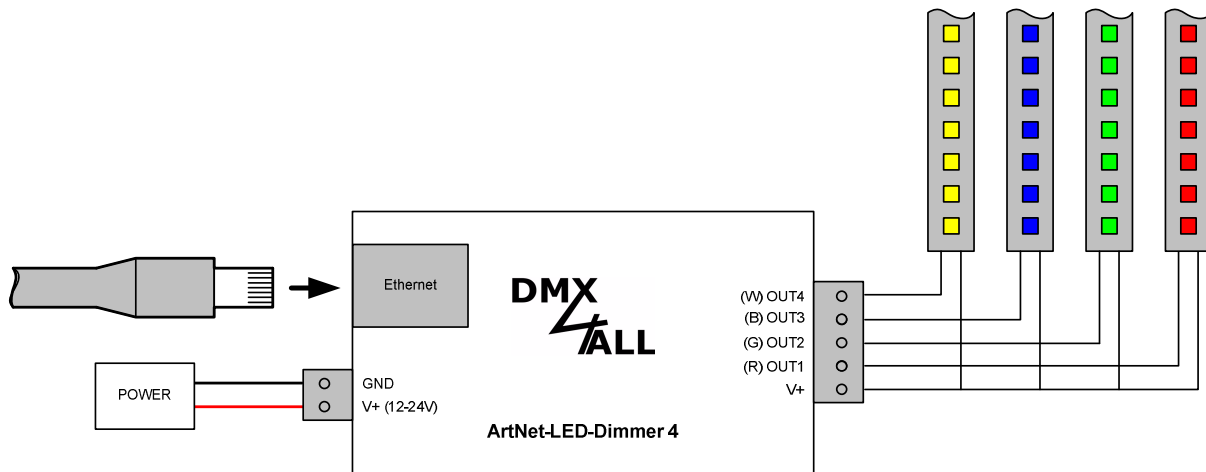

Set the IP with IP-Configurator

The **IP-Configurator** allows setting the IP-Address and net mask setting also, if the net work setting of the PC is not in the range of the IP range of the ArtNet-LED-Dimmer 4 MK2.

- Install the program IP-Configurator
- Connect the ArtNet-LED-Dimmer 4 with the net work and start it
- Start the program IP-Configurator

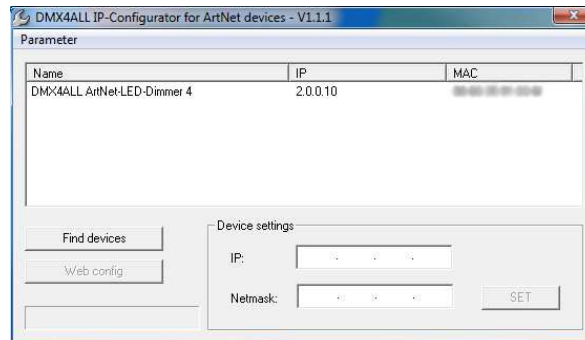

- The ArtNet-LED-Dimmer 4 MK2 is shown in the list
- Select the entry (click)
- Enter the new IP and net mask
- Click SET

Set the IP with web browser

The assigned **IP-Address** within the delivery status is **2.0.0.10** which will be used for the web-interface.

Please set the net work card of your computer to this IP range to call the IP-Address 2.0.0.10 via the web browser.



The network settings of the computer must be set to the **IP-Address 2.0.0.1** and the **subnet mask** must be **255.0.0.0**.

Please take further details from the ArtNet-Specifications.

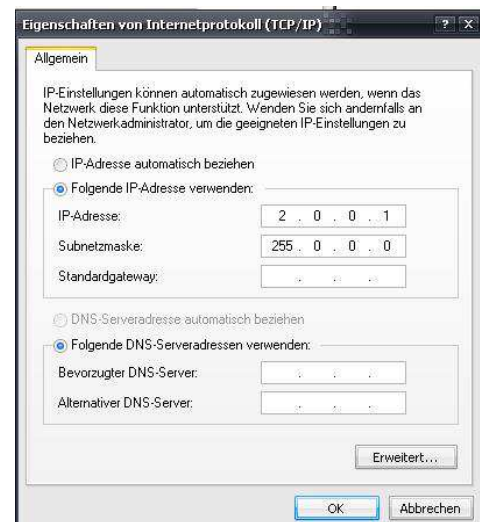

Device Configuration

Call the IP for the ArtNet-LED-Dimmer 4 MK2 in the web browser and within the address bar (delivery status: 2.0.0.10) to get the following configuration page:



Each node needs an own **IP-Address** so the assignment can occur clearly within the network. Use in accordance to the ArtNet-Specifications the IP-Address 2.x.x.x or 10.x.x.x

The **Netmask** is according to the ArtNet-Specifications 255.0.0.0 .

TIP:

Any other IP-Address can also be used e.g. 192.168.1.10 .
In this case the netmask has to be fitted to 255.255.255.0 !

For a better distinction you can give every ArtNet-Node any name.
The **Short-name** is limited to 18 marks and the **Long-name** is limited to 64 marks.

In the ArtNet Settings the settings for the **Subnet**, **Net** and **Port** (Universe) are available.

The **DMX-Start address** specifies the channel in the DMX-Universe on which the LED-Outputs are to be addressed. The DMX-Start address is output 1 and following addresses are outputs 2-4.

The **Master Dimmer** is to activate if all outputs should be dimmed simultaneously with an additional ArtNet-Channel. This is possible in the StandAlone-Operation as well as in the ArtNet-Operation. Thereby the Master-Channel is the first one. An adjustable **Default** value specifies which value is outputted from the Master dimmer after turning on the Dimmer.

StandAlone allows the running without connection to an ArtNet-Control. The set program is executed by turning on the device.

If data are received from an ArtNet-Control for one output with a value higher 0, so the program shut down automatically and the outputs assume the values specified by the received ArtNet-Signal.

Restart determines after which time the StandAlone-Program will be started, if no ArtNet-Signal is received.

Enable ArtNet-Master for StandAlone serves for outputting the StandAlone-Programs via ArtNet. The data beginning with the DMX start address is sent broadcast to the ArtNet-Devices. The Net/SubNet/Universe settings are used for this transfer. So it is possible to run several ArtNet-LED-Dimmer in sync.

A user defined color gradient can be used with **User Color**. The **User Color Setup** is described on the following pages.

If the option **LED indicator auto off** is activated, the LEDs at the device are shut down after 10 minutes of operation with a permanent net work connection.

SAVE stores the configuration respectively restores the Factory Settings.

Using other IP-Addresses



The ArtNet-LED-Dimmer 4 MK2 can work with any other IP-Addresses. You can use for your net work the usual IP-Adresses 192.168.1.x . In this case set the net mask to 255.255.255.0 .

Master Dimmer

The **ArtNet-LED-Dimmer 4 MK2** has a Master-Dimmer to dim all outputs simultaneously. The Master-Dimmer is to activate via web configuration.

The ArtNet-Channel is used as Master-Dimmer for all 4 outputs which is set as start address. The assignment is as follows:

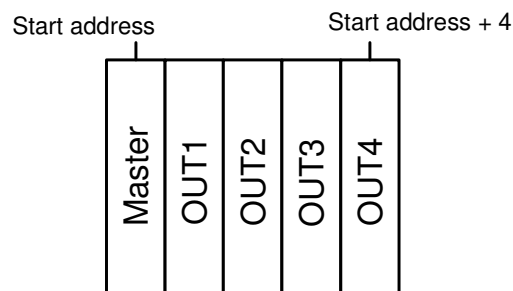

If no Master-Dimmer is activated the assignment for the addresses is as follows:

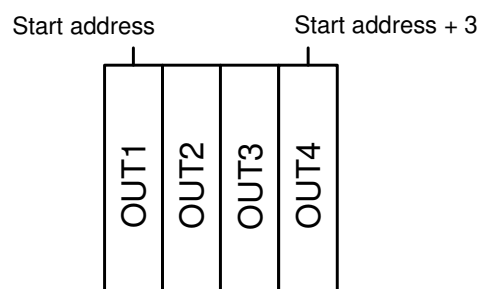

It is also possible to dim the replayed StandAlone-Programs respectively the user defined color changes.

The Default-Value specifies the value the Master-Dimmer work with after turning on the device.



Furthermore, it is possible to change the Master-Dimmer via ArtNet during the StandAlone-Program replay. In this case all values for the outputs are to leave on 0!

If an output value higher 0 is received the replay shuts down and a Live-Output of the received data occurs.

User defined color changes/programs

The **ArtNet-LED-Dimmer 4 MK2** has more than 10 user defined color changes / programs (User Color) allowing to create free defined color replays up to 16 steps.

The delivery status has predefined programs for the operation with RGB-LED-Stripes. All programs (User 1 – User 10) are editable freely.

Editing via web browser

To edit a program it must be selected in the main menu program ① and then the program *Step Editor* ② is to call up.

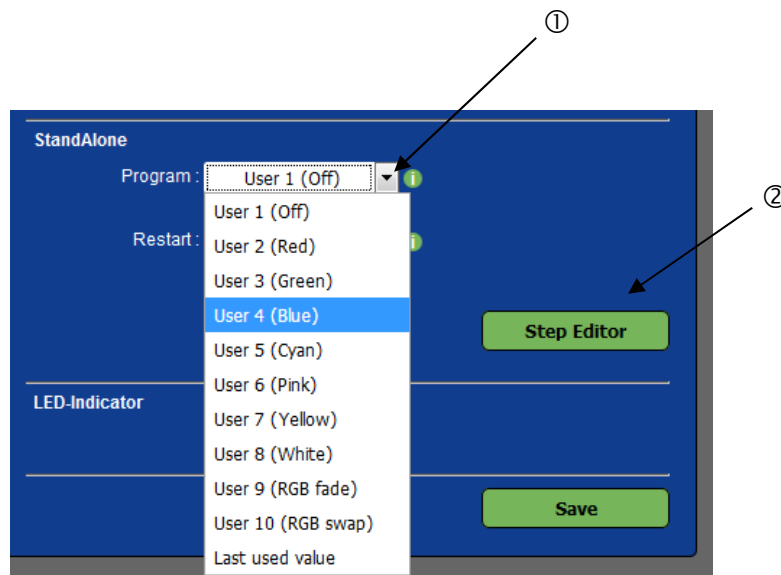

By tapping *Step Editor* in the main menu of the web interface the dialog window USER STEP EDITOR is shown for editing the user defined color changes / program:

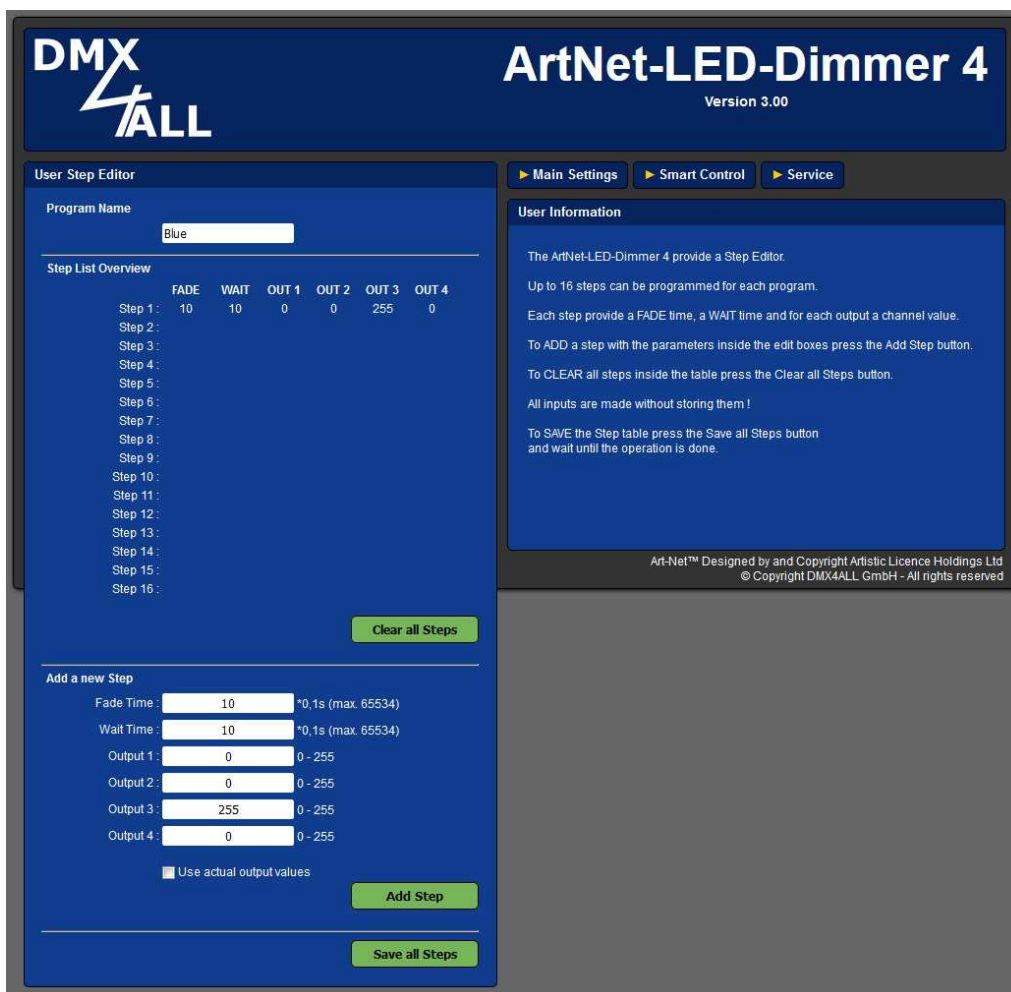

In *Step List Overview* a table shows the 16 current steps (Step1 up to Step 16). Not assigned steps are not shown in the table.

Each steps contains a fade time (FadeTime), a wait time (WaitTime) and 4 brightness values for the outputs (OUT1 - OUT4).

Name user defined programs

For an easy recognition of the created program it is named. This name is used for calling up within the Remote-App.

Delete user defined programs

By clicking *Clear all Steps* the whole table is deleted.

Create steps

In *Add Step* the values for a new step are entered.

The *Fade Time* is in 0,1s units between 0 and 65000. A value of 10 complies with one second and a value of 600 complies with 1 minute.

The *Wait Time* is the same in 0,1s units between 0 and 65000. A value of 10 complies with one second and a value of 600 complies with 1 minute.

In the fields *Channel 1* up to *Channel 4* the brightness values 0-255 for the outputs 1 up to 4 is entered. A value of 255 complies with 100%.

By clicking *Add* the step after the last used step is added and transferred to the table.

By activating the selecting box *Use actual channel values* the brightness values from the entering fields are not transferred but the values currently set.

It is possible to set a random color and to transfer it as step in the user defined color change. The *Fade Time* and *Wait Time* are to set also.



The table is to save with *Save*. If *Save* is not executed the settings are not transferred permanently.

Save user defined programs

With click to *Save all Steps* the table is stored in the ArtNet-LED-Dimmer 4^{MK2}. After turning on the device the color change is replayed until another setting occurs via Ethernet e.g. in the App.

Control via Smart Control

The **ArtNet-LED-Dimmer 4 MK2** offers the possibility to control the outputs via web interface with a color picker or slider.

Thereto please select the Smart Control page:

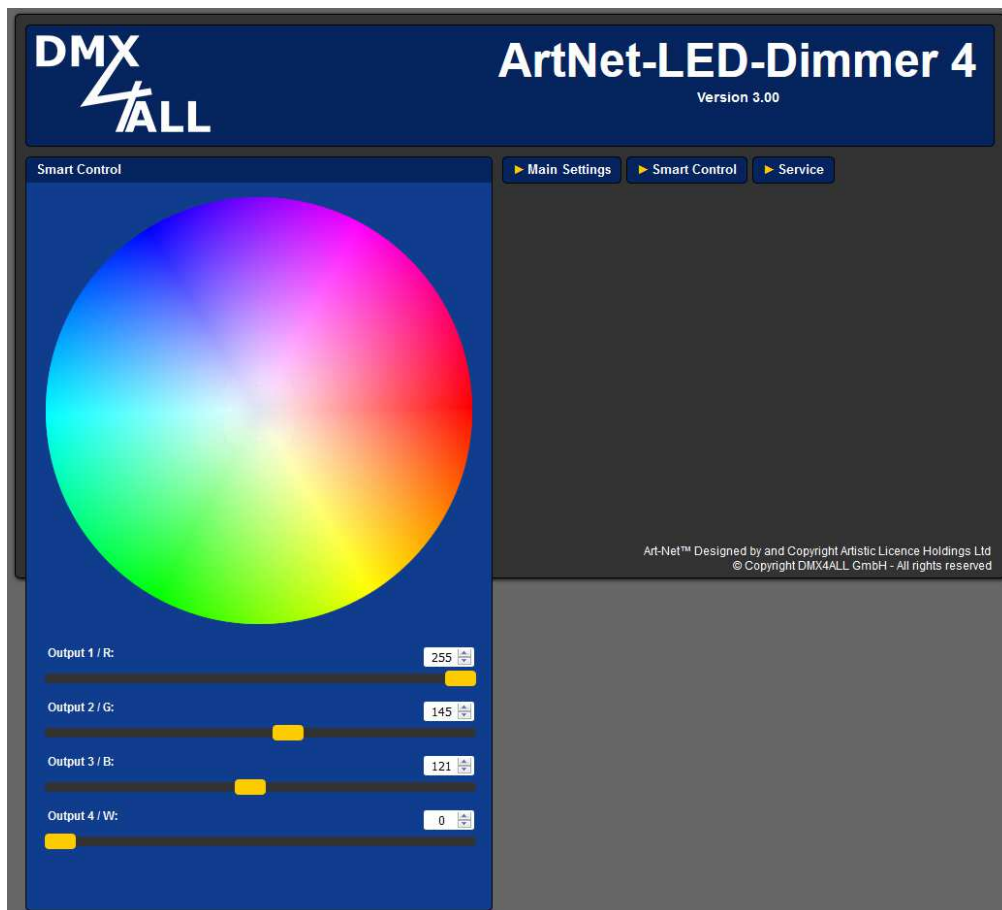

Moving the mouse over the color circle, the color is transferred to the sliders and to the value display. Clicking left the current color value is transferred to the LED-Outputs of the **ArtNet-LED-Dimmer 4 MK2**.

By moving the sliders over the value display is updated, by leaving the current value is transferred to the LED-Output of the **ArtNet-LED-Dimmer 4 MK2**.

Execute program / edit via Android App

The user defined color changes / programs of the ArtNet-LED-Dimmer 4 MK2 can be called up or edit via the Android App DMX4ALL Remote.

The App **DMX4ALL Remote** is available for free in the Google Play-Store and can be installed with each Smartphone or Tablet with Android 4.0 or higher.

After starting the app for the first time the ArtNet-LED-Dimmer 4 MK2 IP must be entered in the Main-Settings .

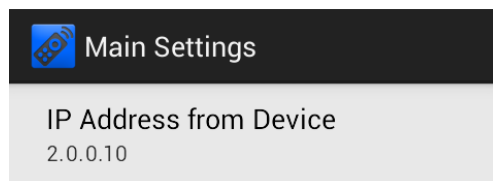

The programs of the ArtNet-LED-Dimmer 4 MK2 are loaded and shown in the list after leaving the settings.

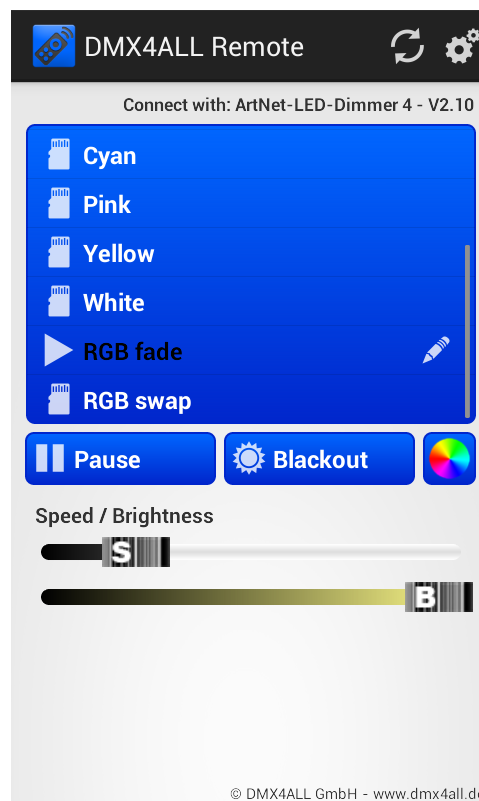

By tapping the programs name in the list the program is executed in the ArtNet-LED-Dimmer 4 MK2. The executed program is signed with the symbol ▶ .

By tapping  the running program stops.

With  the stopped program runs further.

By tapping  the outputs are turned off respectively on. If the Blackout-Function is activated this button is shown in red.

With  the RGB Channel Control opens. With this function the ArtNet-LED-Dimmer 4 MK2 can be used in a live operation.

To set the playback rate and the brightness two sliders (Speed, Brightness) are available.

Edit programs



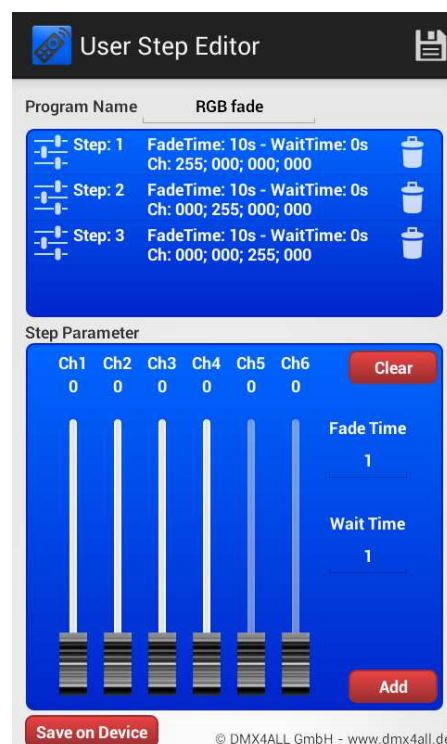





To edit a program the programs name in the list must be pressed for a while (ca. 1 second). A *User Step Editor* opens:



A list with all steps is shown. Each entry specifies the Fade Time, Wait Time and the channel values.

Above the list the programs name is shown, editable too.

Short tapping on the entry select this and the values are shown in the area (Step Parameter) underneath as well as transferred to the ArtNet-LED-Dimmer 4 MK2. The entry is assigned dark.

	Step: 1	FadeTime: 10s - WaitTime: 0s	
		Ch: 255; 000; 000; 000	
	Step: 2	FadeTime: 10s - WaitTime: 0s	
		Ch: 000; 255; 000; 000	
	Step: 3	FadeTime: 10s - WaitTime: 0s	
		Ch: 000; 000; 255; 000	

Keeping an entry pressed for a long time deletes the selected step.

The area **Step Parameter** displays the set values. The sliders set the channel values and transfer these to the ArtNet-LED-Dimmer. So the set light picture can be checked.

The **Fade Time** and **Wait Time** specify the fade time and the wait time for each step in seconds.

At the end of the list a step with the current values is added with **Add**. The values are set by Step Parameter.

Replace replaces the selected entry with the current Step Parameter-Values.

Clear deletes all entries in the list.

Save on Device stores the created program on the ArtNet-LED-Dimmer 4 MK2.

A request appears if the program should be stored (*Save Steps only*) or if the program should be stored and used as start program (*Save Steps + Set as start program*).



Save Program

Do you want to save ?

Save nothing	Save steps only	Save steps + Set as start program
--------------	-----------------	-----------------------------------

Export / Import programs

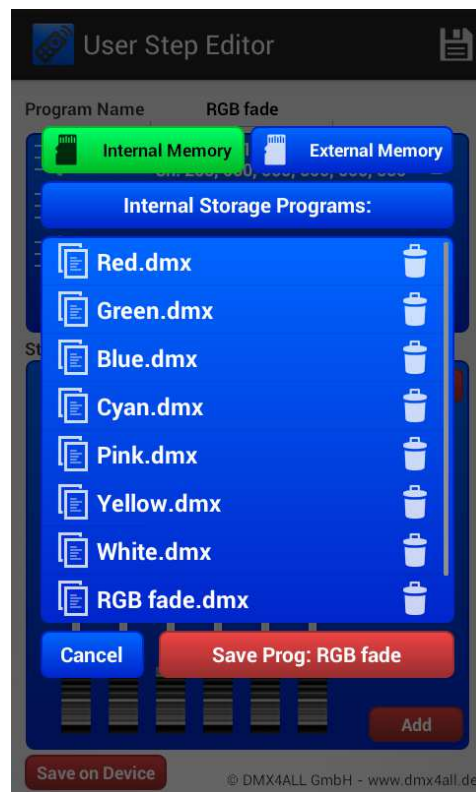
With  it is possible to export respectively to import a created program as file on a smartphone / tablet.



To export / import the internal storage (Internal Memory) as well as the external storage from a SD-Card (External Memory) can be used.

By tapping to **Internal Memory** respectively **External Memory** a storage location is selected.

The shown file (.dmx) can be load by **tapping** and deleted by **hold down long**.

Save the current program occurs by tapping **Save Prog**.
The files' name is assigned automatically.

Live-Usage per App

The ArtNet-LED-Dimmer 4 MK2 can be controlled live via App.

Android Smartphones / Tablets

- **Light Remote LITE** (fee required)

App for easy remote control of Art-Net-Installations integrating a user friendly design, an attractive surface with easy possibilities for color settings.

⇒ Recommended for installations with one ArtNet-LED-Dimmer



- **Light Remote** (fee required)

App for easy remote control of Art-Net-Installations integrating a user friendly design, an attractive surface with easy possibilities for color settings.

⇒ Recommended for installations with several ArtNet-LED-Dimmer

iOS Smartphones / Tablets

- **Luminair** (fee required)

App to control devices via Art-Net.



Running with WLAN

The **ArtNet-LED-Dimmer 4 MK2** can also be operated at a WLAN Router/Access-Point or at a WLAN-Bridge.

Running at WLAN Router/Access-Point

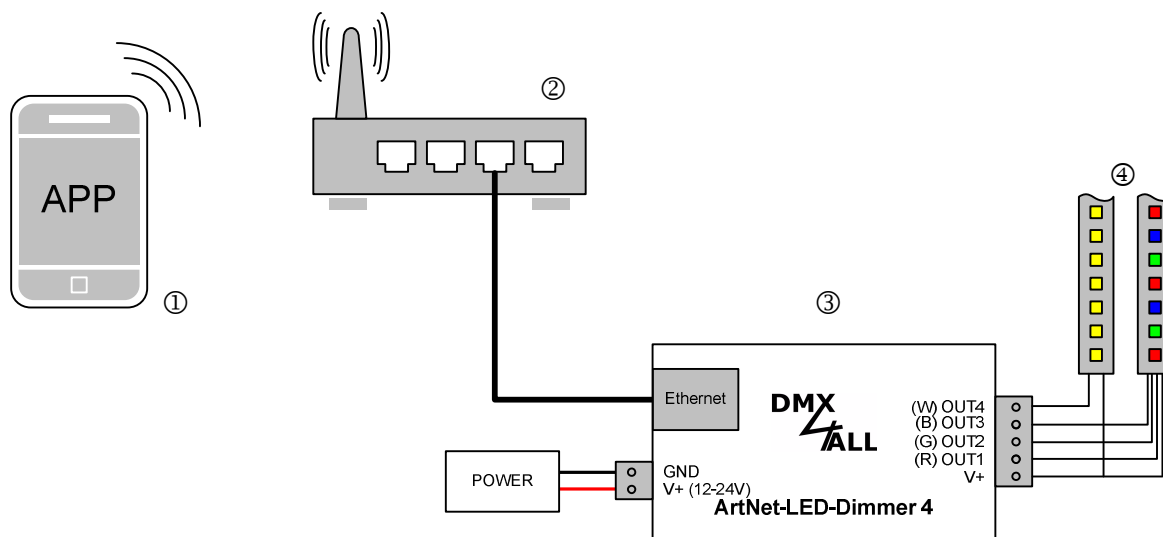

Running at WLAN- Bridge

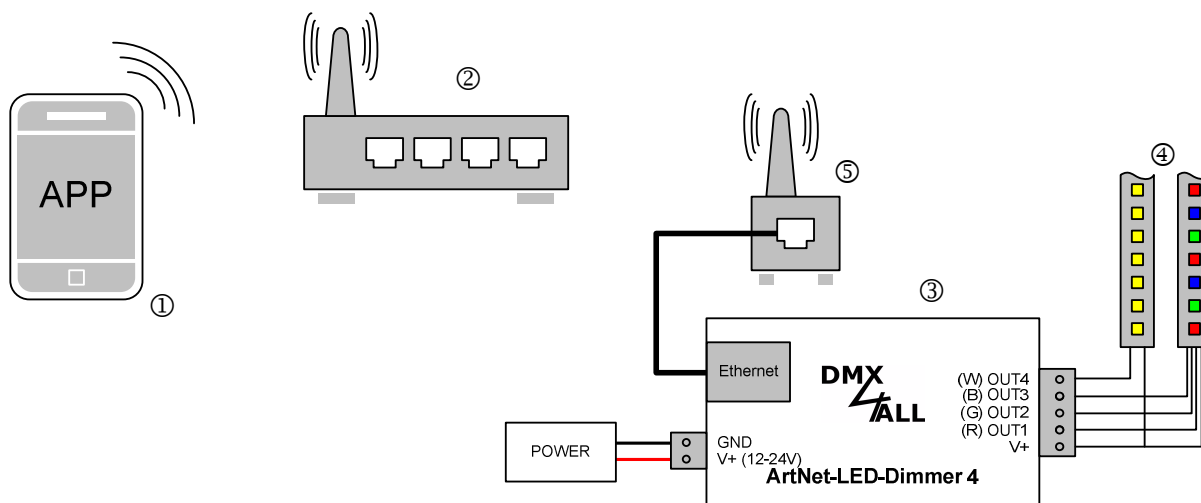

- ① Smartphone / TabletPC
- ② WLAN Router/Access-Point
- ③ ArtNet-LED-Dimmer 4 MK2
- ④ LED-Stripe
- ⑤ WLAN-Bridge e.g. TP-Link

Factory Reset

To reset the **ArtNet-LED-Dimmer 4 MK2** into the delivery status please proceed as follows:

Restore the delivery status via **web browser**:

- Open the service site in the web browser
- Enter the service code „7319“
- Click *Save*
- Following please wait minimum 10 seconds



If a reset is executed via website, so the IP-Address as well as the subnet mask are reset. A return can't take place always. If necessary please set the IP again (see *Set the IP with IP-Configurator* or *Set IP with web browser*).

Restore the delivery status via **DMX4ALL LAN-Updater**:

- Turn on the device
- Start software **DMX4ALL LAN-Updater**
- Click **FIND**
- Select the **ArtNet-LED-Dimmer 4 MK2** from list
- Click **FACTORY RESET**
- The reset will be execute now

Restore the delivery status via **DMX4ALL IP-Configurator**:

- Turn on the device
- Start software **DMX4ALL IP-Configurator**
- Click **FIND**
- Select the **ArtNet-LED-Dimmer 4 MK2** from list
- Click **FACTORY RESET**
- The reset will be execute now

Execute Firmware-Update

The **ArtNet-LED-Dimmer 4 MK2** has an update-function which enables transferring prospective firmware-versions.

Proceed as follows:

- Turn off the device
- Start update software **DMX4ALL LAN-Updater**
- Generate a network connection to PC
- Turn on the device
- The yellow LED lights for around 3 seconds
- During the yellow LED is on press **FIND**
- Select the **ArtNet-LED-Dimmer 4 MK2** from list
- Click *Firmware-Update*
- Select and confirm Firmware-File (.bin)
- Please wait until the update has finished



If an error occurs you can begin from the start anytime.

Alternatively, you can activate the firmware update through the web browser:

- Open within the web browser *Service*
- Enter the service code „1379“ and click *Save*
- Start update software **DMX4ALL LAN-Updater**
- Select **ArtNet-LED-Dimmer 4 MK2** from list
- Click *Firmware-Update*
- Select and confirm Firmware-File (.bin)
- Please wait until the update has finished
- Click *Back* within the web browser

Dimensions

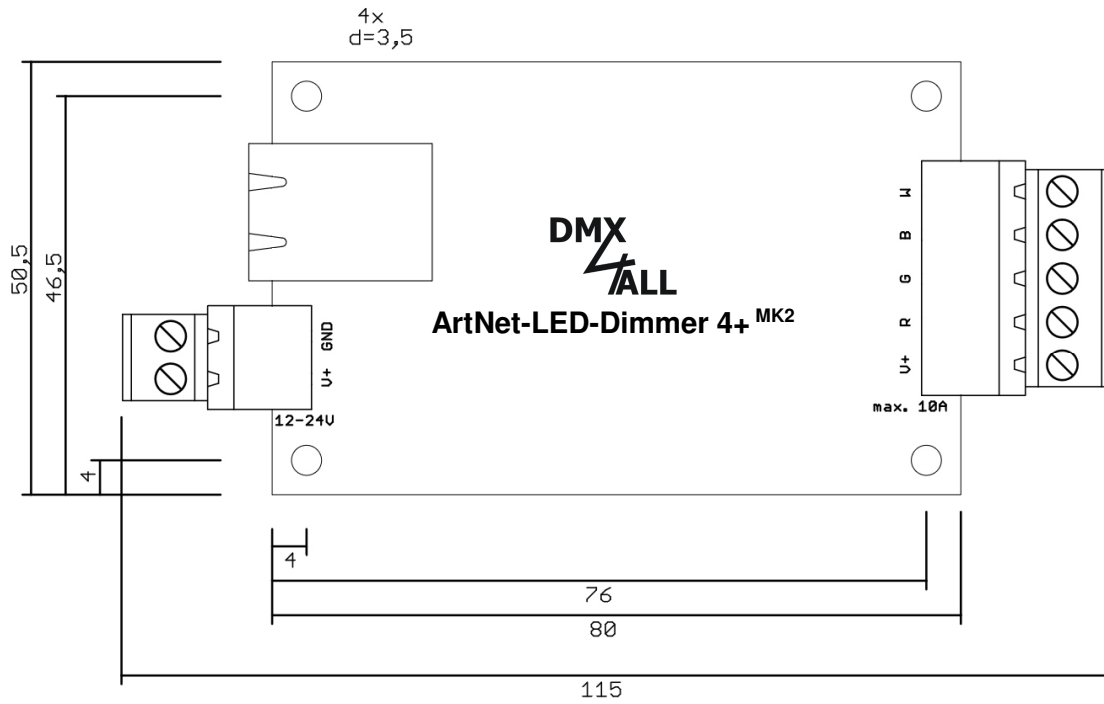

All details in mm

Accessory

LED-Stripe RGB



LED-Stripe WHITE



Power supply



Housing 1455C801



CE-Conformity



This assembly (board) is controlled by a microprocessor and uses high frequency. In order to maintain the properties of the module with regard to CE conformity, installation into a closed metal housing in accordance with the EMC directive 2014/30/EU is necessary.

Disposal

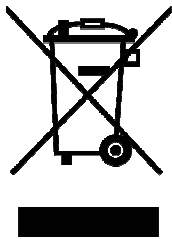

Electronical and electronic products must not be disposed in domestic waste. Dispose the product at the end of its service life in accordance with applicable legal regulations. Information on this can be obtained from your local waste disposal company.

Warning



This device is no toy. Keep out of the reach of children. Parents are liable for consequential damages caused by nonobservance for their children.

Risk-Notes



You purchased a technical product. Conformable to the best available technology the following risks should not be excluded:

Failure risk:

The device can drop out partially or completely at any time without warning. To reduce the probability of a failure a redundant system structure is necessary.

Initiation risk:

For the installation of the board, the board must be connected and adjusted to foreign components according to the device paperwork. This work can only be done by qualified personnel, which read the full device paperwork and understand it.

Operating risk:

The Change or the operation under special conditions of the installed systems/components could as well as hidden defects cause to breakdown within the running time.

Misusage risk:

Any nonstandard use could cause incalculable risks and is not allowed.

Warning:

It is not allowed to use the device in an operation, where the safety of persons depend on this device.



DMX4ALL GmbH
Reiterweg 2A
D-44869 Bochum
Germany

Last changes: 28.01.2022

© Copyright DMX4ALL GmbH

All rights reserved. No part of this manual may be reproduced in any form (photocopy, pressure, microfilm or in another procedure) without written permission or processed, multiplied or spread using electronic systems.

All information contained in this manual was arranged with the greatest care and after the best knowledge. Nevertheless, errors are to be excluded not completely. It is pointed out that neither a guarantee nor the legal responsibility or any liability for consequences which are due to incorrect information is assumed. This document does not contain assured characteristics. The guidance and the features may be changed at any time and without previous announcement.